

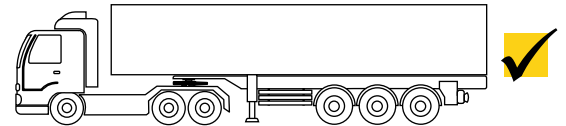

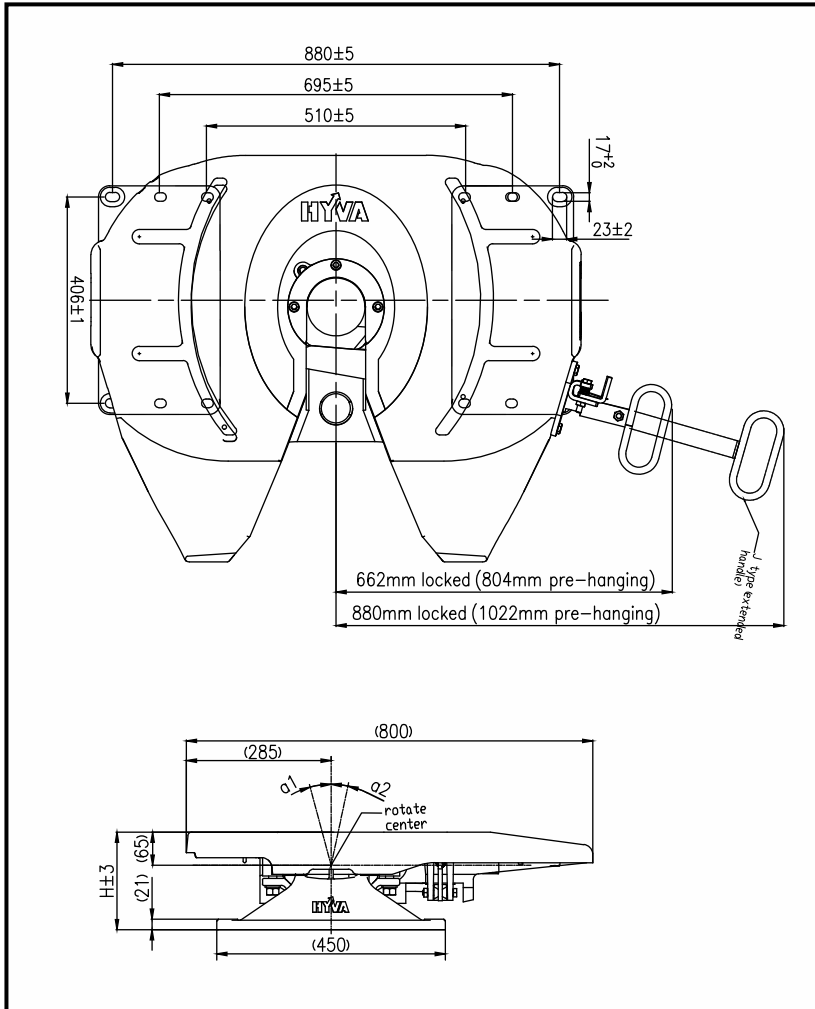



TECHNICAL SPECIFICATIONS



	H	α							
Part number	Height (mm)	α (degrees)	D value (kN)	U value (kN)	Weight (kg)	Handle type	Remote indicator	Remote opening	ECE R55-02 Approval
FW2016000	160	±12°	260	38.5	181				E32-55R02-0215
FW2016100	160	±12°	260	38.5	181.5	J			E32-55R02-0215
FW2019000	190	±15°	260	38.5	187				E32-55R02-0215
FW2019100	190	±15°	260	38.5	187.5	J			E32-55R02-0215
FW2025000	250	±15°	260	38.5	210				E32-55R02-0215
FW2025100	250	±15°	260	38.5	210.5	J			E32-55R02-0215

SPARE PARTS



Pos.	Part no.	Description	Qty.
01	HSF00030	Wearing ring kit	1
02	HSF00032	Lock jaw kit	1
03	HSF00034	Locking bar	1
04	HSF00035	Lever plate kit	1
05	HSF00036	Pull handle kit	1
05J	HSF00055	Pull handle long J kit	1
06	HSF00037	Adjusting screw kit	1
07	HSF00038	Handle groove plate assembly	1
08	HSF00039	Latch kit	1
09	HSF00040	Cover Plate	2
10	HSF00041	Rubber bushing kit	2

Pos.	Part no.	Description	Qty.
11	HSF00042	Locking bar bolt kit	1
12	HSF00043	Lever cover kit	1
13	HSF00044	Locking Jaw Bolt	1
14	HSF00045	Double tension spring kit	1
15	HSF00048	Pedestal 160mm	1
	HSF00047	Pedestal 190mm	1
	HSF00049	Pedestal 250mm	1
16	HSF00050	Lock Jaw greasing kit	1
17	HSF00051	Grease supply subassembly	1
18	HSF00052	Release lever subassembly	1
19	HSF00053	Release lever subassembly Collar	1
20	HSF00054	Cover plate screw bolt subassembly	8