

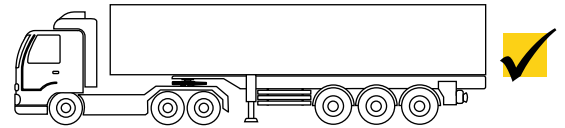

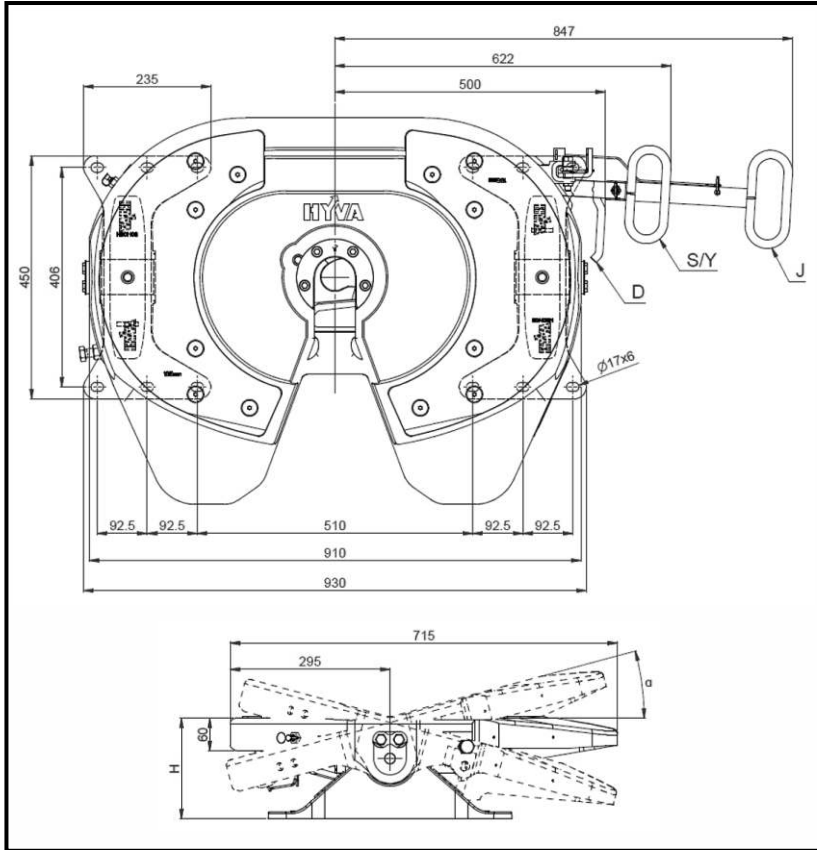

TECHNICAL SPECIFICATIONS

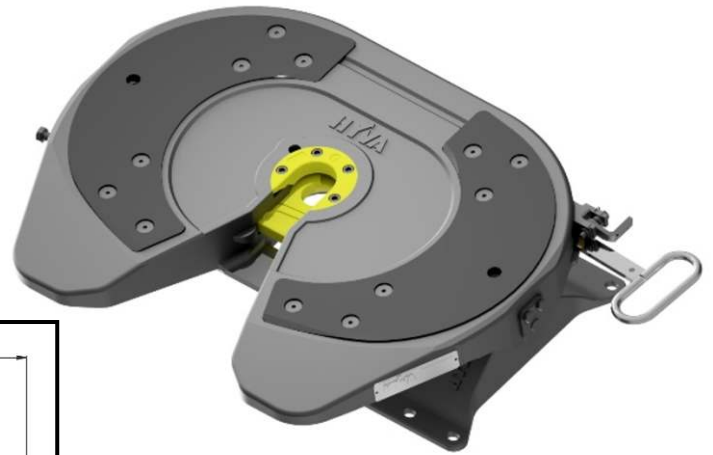
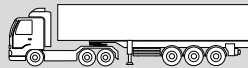

ISO 337
ECE R55 CLASS G50

Part number	H	α							ECE R55-02 Approval
	Height (mm)	α (degrees)	D value (kN)	U value (kN)	Weight (kg)	Handle type	Remote indicator	Remote opening	
FW0213000	135	$\pm 12^\circ$	170	25	120				E32-55R02-0164
FW0213100	135	$\pm 12^\circ$	170	25	120	J			E32-55R02-0164
FW0215000	150	$\pm 15^\circ$	170	25	121				E32-55R02-0164
FW0215100	150	$\pm 15^\circ$	170	25	121	J			E32-55R02-0164
FW0217000	172	$\pm 15^\circ$	170	25	122				E32-55R02-0164
FW0217100	172	$\pm 15^\circ$	170	25	122	J			E32-55R02-0164
FW0218000	185	$\pm 15^\circ$	170	25	123				E32-55R02-0164
FW0218100	185	$\pm 15^\circ$	170	25	123	J			E32-55R02-0164
FW0220000	205	$\pm 15^\circ$	170	25	124				E32-55R02-0164
FW0220100	205	$\pm 15^\circ$	170	25	124	J			E32-55R02-0164
FW0222000	225	$\pm 15^\circ$	170	25	125				E32-55R02-0164
FW0222100	225	$\pm 15^\circ$	170	25	125	J			E32-55R02-0164

SPARE PARTS



Pos.	Part no.	Description	Qty.
01	HSF00001	Wearing ring kit	1
02	HSF00002	Lock jaw kit	1
03	HSF00023	Locking bar	1
04	HSF00004	Lever plate kit	1
05	HSF00005	Pull handle kit	1
05J	HSF00022	Pull handle long J kit	1
05D	HSF00056	Pull handle shirt D kit	1
05Y	HSF00057	Pull handle bended UP Y kit	1
06	HSF00006	Adjusting screw kit	1
07	HSF00007	Lock block	1
08	HSF00008	Latch kit	1
09	HSF00009	Swivel pin kit	1

Pos.	Part no.	Description	Qty.
10	HSF00010	Rubber bushing kit	1
11	HSF00020	Locking bar bolt kit	1
12	HSF00012	Hole pivot kit	1
13	HSF00013	Pivot	1
14	HSF00014	Double tension spring kit	1
15	HSF00015	Pedestal 150mm	2
	HSF00019	Pedestal 172mm	2
	HSF00017	Pedestal 185mm	2
	HSF00018	Pedestal 135mm	2
	HSF00020	Pedestal 205mm	2
	HSF00021	Pedestal 225mm	2
16	HSF00016	Collar	1
17	HSF00025	Plastic top plate liner kit	1